



SHREE
MS

**MAA SANTOSHI
FABRICATORS**

SHREE

MS

**THE UNIQUE RANGE
OF HOUSEHOLD PRODUCTS**

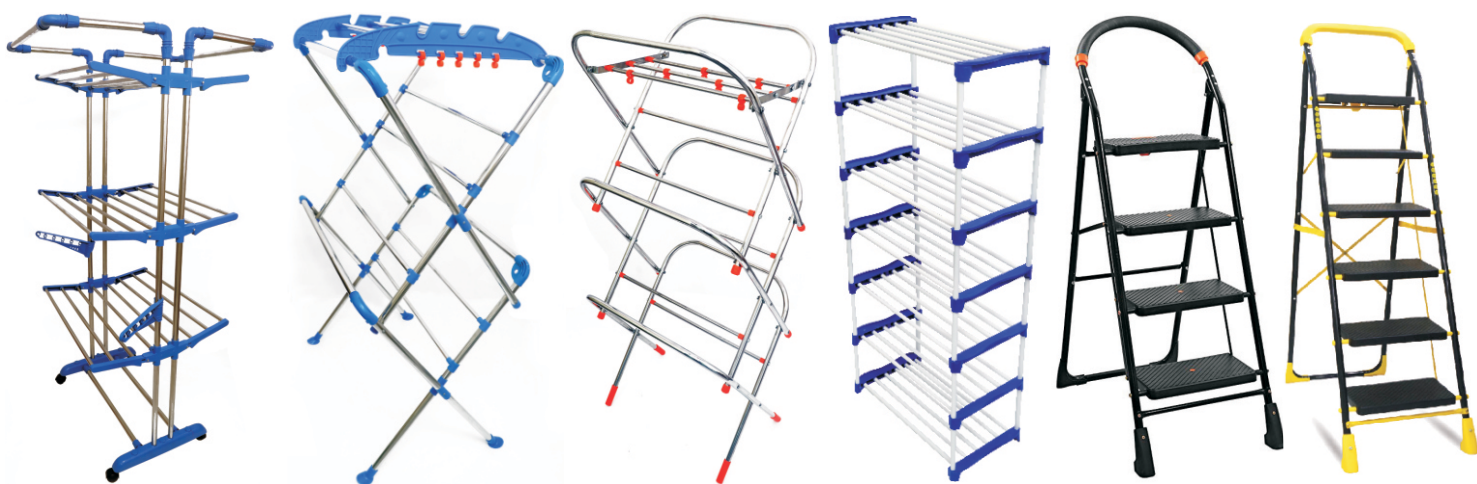

Scan For Our Website



ABOUT US :

Maa Santoshi Fabricators is a well known brand in making of cloth drying stands, ladders, press tables, shoe cabinet & shoe racks etc. making more than 100 products from last 40 years, maintaining quality of products for used in every households. Maa Santoshi Fabricators is fastest growing with existing brands of all usage production in the Country. Our Products are beautifully designed to make life easy and comfortable.

We are committed to bring latest style & finishing in our products with the assurance of best quality. We are aware of the value of hard earned money of our customers. We always welcome the suggestions of our valuable customers. We have ensured our position as a value partner in the design and manufacturers of Home Utility Products. We strongly believe to provide good quality products at competitive prices.

Presently more than thousands families are using our products satisfactory and our endeavours is grow our family.

We strongly believe to provide good quality products at competitive prices. All the products we manufacture reduce the import burden of the country. It can be fold down and extend out to conserve space. You can either hang more clothes on or save more space which is great for both Indoor & Outdoor using. Cloth Drying Stands comes with all parts well labelled and straight forward Instructions.

It doesn't take a lot of Manual Work to Pull it together.

S.No.	CONTENTS :	GST	HSN Code
1.	Cloth Drying Stands (Iron / Steel)	5%	732399
2.	Pooja Chair / Meditation Chair	18%	940310
3.	Storage Rack / Multipurpose Rack	18%	940310
4.	Ladders (Iron / Alluminium)	18%	761699
5.	Racks (For Kitchen/Books/Shoes) Iron/Steel	18%	940310
6.	Wall Mounted Shoe Cabinet Iron	18%	940350
7.	Study Table / Kids Table	18%	940310
8.	Press Table / Press Table Mesh	18%	940310

Movement	:	Advanced can be provided at the bottom to prevent the stand from sliding away from its position.
Making	:	Proudly made in India using all made in India Components.
Guarantee	:	Rust Proof guarantee with stainless steel pipes and fastners as well as unbreakable plastic fixtures.
Storage	:	Foldable hanging frames ensure that it takes up minimum space when not in use.

Quality & FEATURES :

- **Durable Construction** - Made with strong, High-Quality Materials for long-lasting performance.
- **Foldable Design** - Easy to fold and store when not in use, saving valuable space.
- **Ample Drying Space** - Multiple rods provide sufficient room for drying large loads of laundry.
- **Rust-Resistant Coating** - Protects against corrosion and ensures long life.
- **Light Weight & Portable** - Can be easily moved indoors or outdoors and needed.
- **Easy Assemble** - Simple setup without the need for tools.
- **Eco-Friendly** - A sustainable alternative to electric dryers.

Mfg. By : **MAA SANTOSHI FABRICATORS**

*Premium Range of
Home Utility Products*





Follow us :



MS

THE UNIQUE RANGE
OF HOUSEHOLD PRODUCTS

Manufactured by :

MAA SANTOSHI FABRICATORS

GST NO. : 07ALBPK4531E1ZJ

📍 Shiv Vihar Colony, Karala, Delhi-110081

☎ 7888388849 📞 +91-9810299260

✉ msfabricators89@gmail.com

🌐 www.maasantoshifabricators.net
ms.thankyoubuyers.com ; msfabricator.in

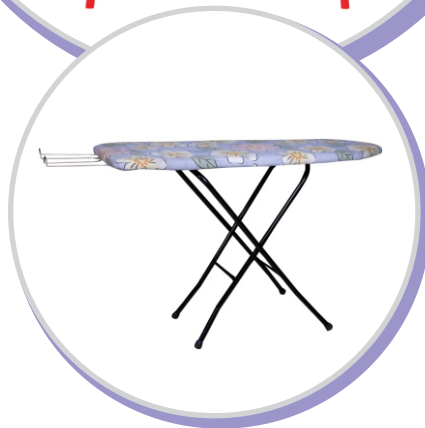
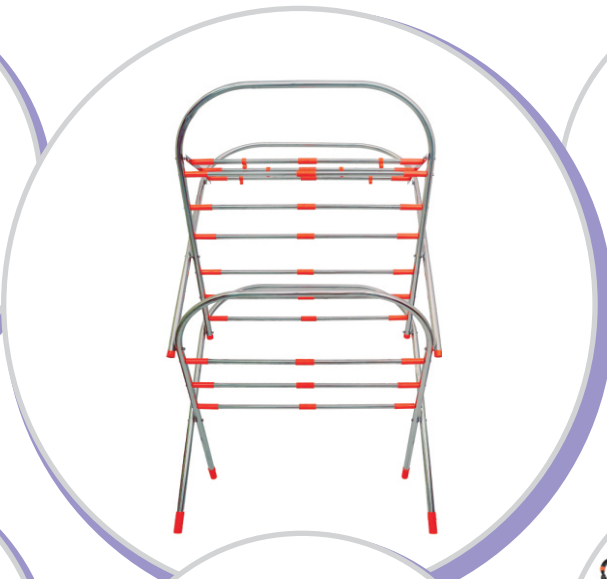
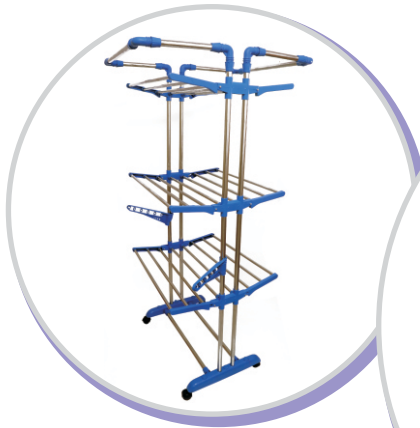
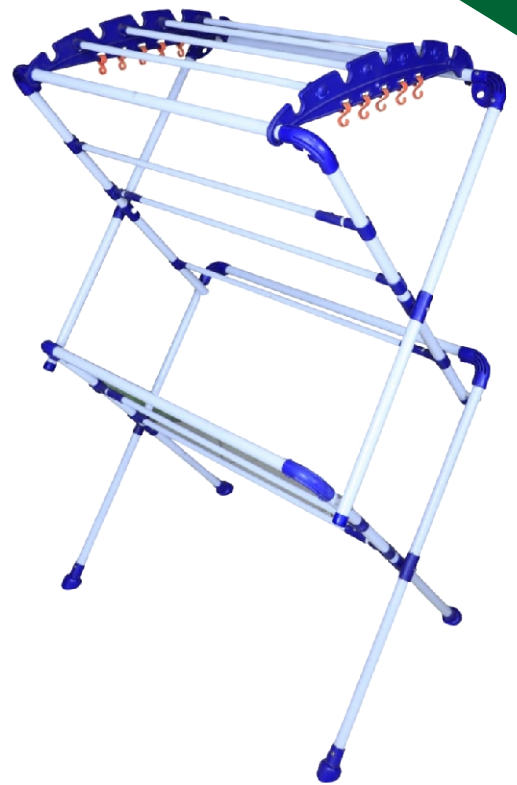



CLOTH DRYING STANDS

STORAGE SAVE SUITABLE FOR BOTH INDOOR & OUTDOOR

01



107

Height : 3.5 ft.
Width : 2 Ft
Rod : 7
Outer Pipe : 1 Inch
Inner Pipe : 5/8
Weight : 2.5 Kg.

STAINLESS STEEL

02



109

Height : 5 ft.
Width : 3 Ft
Rod : 9
Outer Pipe : 1 Inch
Inner Pipe : 1/2 inch
Weight : 3.5 Kg.

STAINLESS STEEL

03



1012

Height : 6 ft.
Width : 3 Ft
Rod : 12
Outer Pipe : 1 Inch
Inner Pipe : 1/2 Inch
Weight : 4 Kg.

STAINLESS STEEL

04



STAINLESS STEEL

13.5 Inch.

36 Inch.



PACKING BOX

3 FOLD

Height : 6 ft.
Width : 3 Ft
Rod : 11
Outer Pipe : 1 Inch
Inner Pipe : 5/8
Weight : 4.5 Kg.

AVAILABLE IN FIX & BOX PACKING

STAINLESS STEEL HEAVY DUTY



CLOTH DRYING STANDS

STORAGE SAVE SUITABLE FOR BOTH INDOOR & OUTDOOR

05

06

SUMO



Width : 3 Ft.
Height : 5 Ft.
Weight : 6.5 Kg.

STAINLESS STEEL

MINI SUMO



Width : 3 Ft.
Height : 2.5 Ft.
Weight : 3.0 Kg.

POWDER COATED IRON

SUMO

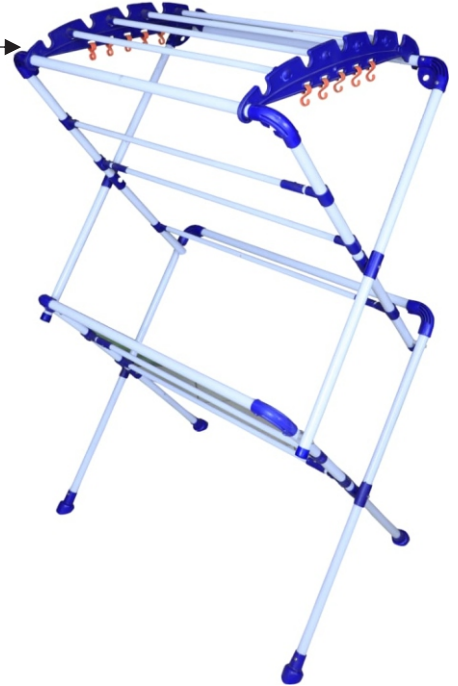

Width : 3 Ft.
Height : 5 Ft.
Weight : 5.0 Kg.

POWDER COATED IRON

DOUBLE LOCK HEIGHT ADJUSTABLE

06

SUMO



Width : 3 Ft.
Height : 5 Ft.
Weight : 5.0 Kg.

POWDER COATED IRON



42.5 Inch.

6 Inch.

9 Inch.

PACKING BOX

DOUBLE LOCK HEIGHT ADJUSTABLE

06

SUMO



Width : 3 Ft.
Height : 5 Ft.
Weight : 5.0 Kg.

POWDER COATED IRON

AVAILABLE IN FIX & BOX PACKING

STAINLESS STEEL HEAVY DUTY



CLOTH DRYING STANDS

STORAGE SAVE SUITABLE FOR BOTH INDOOR & OUTDOOR

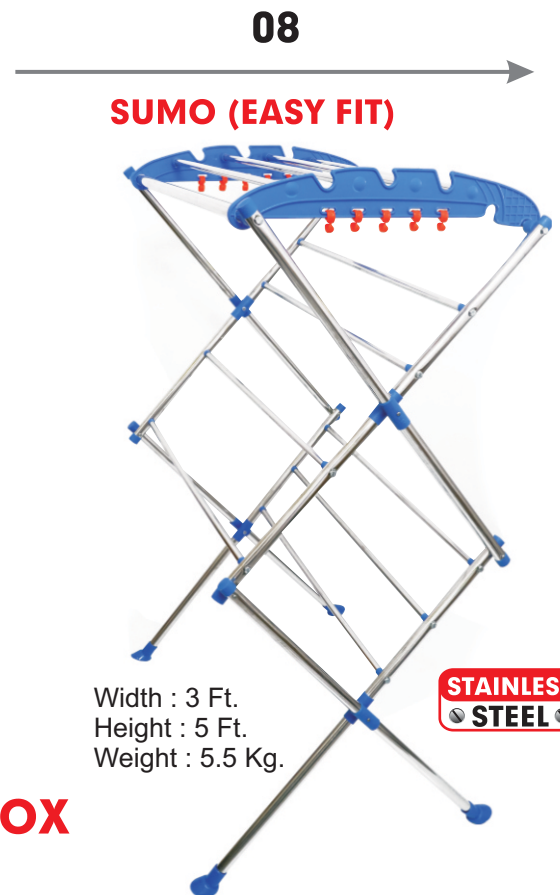

AVAILABLE IN FIX & BOX PACKING

STAINLESS STEEL HEAVY DUTY



CLOTH DRYING STANDS

STORAGE SAVE SUITABLE FOR BOTH INDOOR & OUTDOOR

09



BIG WINGS 2 LAYER

Height : 4 Ft.
Width : 2.5 Ft.
Outer Pipe : 1 Inch
Inner Pipe : 5/8
Weight : 5.5 Kg.



10



BIG WINGS 3 LAYER

Height : 5.5 Ft.
Width : 2.5 Ft.
Outer Pipe : 1 Inch
Inner Pipe : 5/8
Weight : 8 Kg.



11



BIG WINGS FULL SIZE

Height : 6.5 Ft.
Width : 2.5 Ft.
Outer Pipe : 1 Inch
Inner Pipe : 5/8
Weight : 9 Kg.

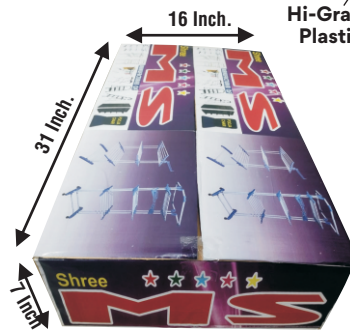
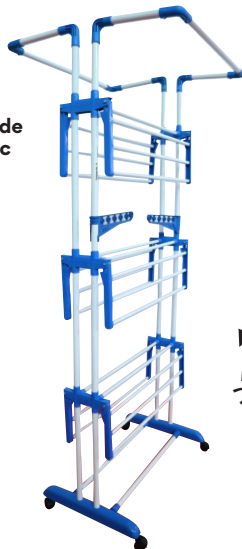

PACKING BOX

AVAILABLE IN FIX & BOX PACKING

IRON MAKE HEAVY DUTY



CLOTH DRYING STANDS

STORAGE SAVE SUITABLE FOR BOTH INDOOR & OUTDOOR

12

BIG WINGS FULL SIZE

Height : 6 Ft.
Width : 2.5 Ft.
Outer Pipe : 6/8
Inner Pipe : 1/2 Inch
Weight : 5.5 Kg.

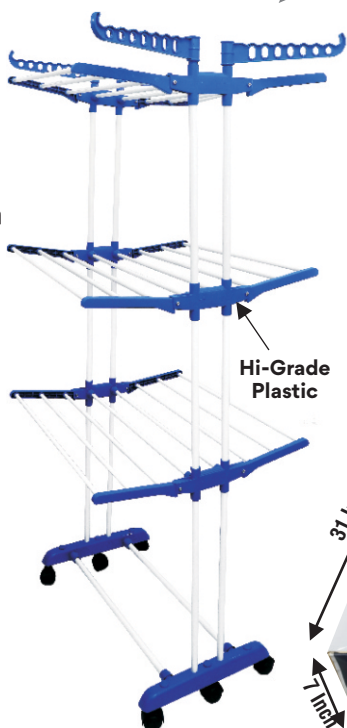

Hi-Grade Plastic

BIG WINGS FULL SIZE

Height : 6 Ft.
Width : 2.5 Ft.
Outer Pipe : 6/8
Inner Pipe : 1/2 Inch
Weight : 5.5 Kg.

STAINLESS STEEL

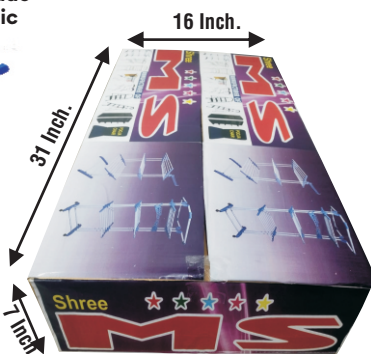

PACKING BOX

12



Hi-Grade Plastic

POWDER COATED IRON

13



Hi-Grade Plastic

BIG WINGS 2 LAYER

Height : 4 Ft.
Width : 2.5 Ft.
Outer Pipe : 1 Inch
Inner Pipe : 5/8
Weight : 5.5 Kg

STAINLESS STEEL

14



Hi-Grade Plastic

Hi-Grade Plastic

BIG WINGS 3 LAYER

Height : 6 Ft.
Width : 2.5 Ft.
Outer Pipe : 1 Inch
Inner Pipe : 5/8
Weight : 7.5 Kg.

STAINLESS STEEL

AVAILABLE IN FIX & BOX PACKING

STAINLESS STEEL HEAVY DUTY



CLOTH DRYING STANDS

STORAGE SAVE SUITABLE FOR BOTH INDOOR & OUTDOOR

15



Hi-Grade Plastic

BIG WINGS PACKING BOX

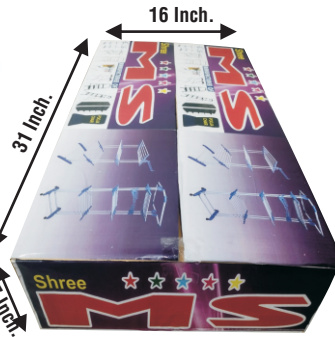

BIG WINGS FULL SIZE

Height : 7 Ft.
Width : 2.5 Ft.
Outer Pipe : 1 Inch
Inner Pipe : 5/8
Weight : 9 Kg.

STAINLESS STEEL

16



AALNA

Height : 5 Ft.
Width : 3.4 Ft.
Weight : 5.5 Kg.

STAINLESS STEEL

Packing Dimension
L-57, W-15, H-4
(In inches)

All stands available with wheels and without wheels (Ready to use)

17



FULL BEND

Height : 5 ft.
Width : 3 Ft
Rod : 4+9
Outer Pipe : 1 Inch
Inner Pipe : 1/2 Inch
Weight : 4 Kg.

STAINLESS STEEL

18



FULL BEND With Wheel

Height : 5 ft.
Width : 3 Ft
Rod : 4+9
Outer Pipe : 1 Inch
Inner Pipe : 1/2 Inch
Weight : 4.5 Kg.

STAINLESS STEEL

AVAILABLE IN FIX & BOX PACKING

STAINLESS STEEL HEAVY DUTY



CLOTH DRYING STANDS

STORAGE SAVE SUITABLE FOR BOTH INDOOR & OUTDOOR

All stands available with wheels and without wheels (Ready to use)

19



FULL BEND MULTI

Height : 6 ft.
Width : 3 Ft
Rod : 4+12
Outer Pipe : 1 Inch
Inner Pipe : 6/8
Weight : 8 Kg.



20

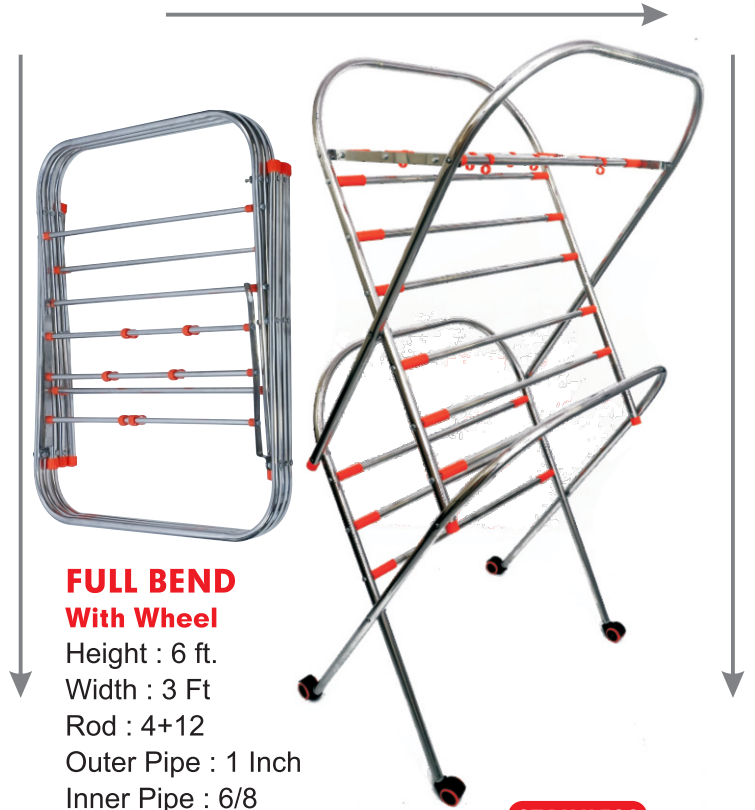

FULL BEND With Wheel

Height : 6 ft.
Width : 3 Ft
Rod : 4+12
Outer Pipe : 1 Inch
Inner Pipe : 6/8
Weight : 8.5 Kg.



21

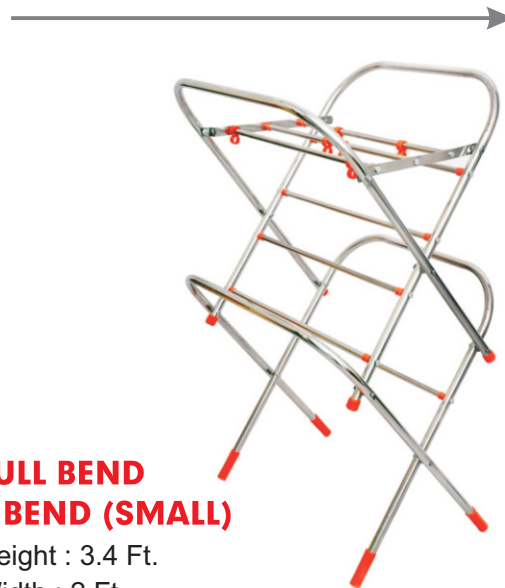

FULL BEND 2 BEND (SMALL)

Height : 3.4 Ft.
Width : 2 Ft.
Rod : 4 + 7
Weight : 2.6 Kg.
Inner Pipe : 1/2 Inch.
Outer Pipe : 6/8 Inch.



22

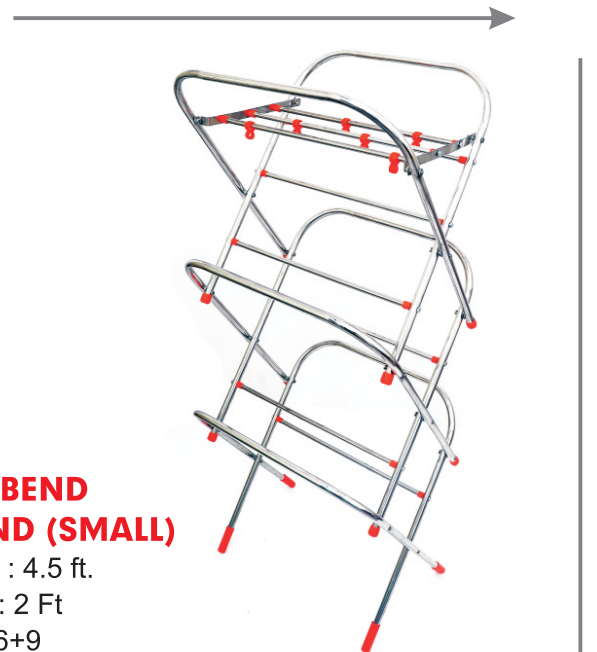

FULL BEND 3 BEND (SMALL)

Height : 4.5 ft.
Width : 2 Ft
Rod : 6+9
Outer Pipe : 6/8
Inner Pipe : 1/2 inch
Weight : 3.5 Kg.



STAINLESS STEEL HEAVY DUTY



CLOTH DRYING STANDS

STORAGE SAVE SUITABLE FOR BOTH INDOOR & OUTDOOR

All stands available with wheels and without wheels (Ready to use)

23



FULL BEND

Height : 5 ft.
Width : 3 Ft
Rod : 4+12
Outer Pipe : 6/8
Inner Pipe : 1/2 Inch
Weight : 5 Kg.



24



FULL BEND

Height : 6 ft.
Width : 3 Ft
Rod : 4+15
Outer Pipe : 6/8
Inner Pipe : 1/2 Inch
Weight : 6 Kg.



25

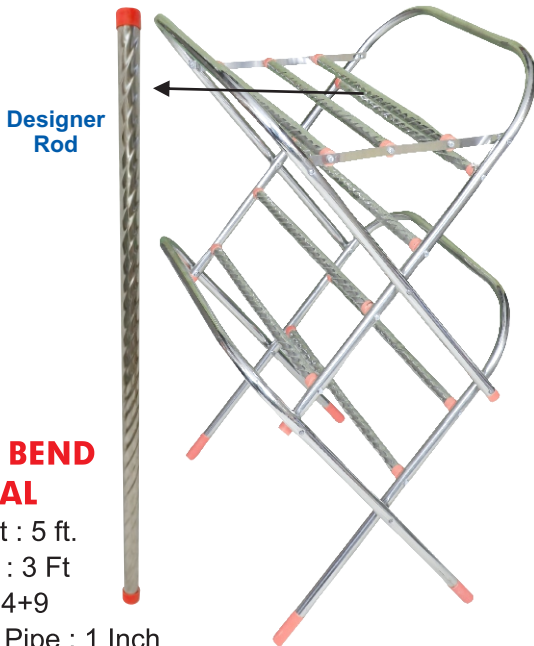

Designer Rod

FULL BEND SPIRAL

Height : 5 ft.
Width : 3 Ft
Rod : 4+9
Outer Pipe : 1 Inch
Inner Pipe : 1 Inch
Weight : 5.5 Kg.



26



FULL BEND

Height : 6 ft.
Width : 3 Ft
Rod : 4+12
Outer Pipe : 6/8
Inner Pipe : 3/8
Weight : 5.5 Kg.
Also available in 9 & 15 Rod



STAINLESS STEEL
HEAVY DUTY



CLOTH DRYING STANDS

STORAGE SAVE SUITABLE FOR BOTH INDOOR & OUTDOOR

All stands available with wheels and without wheels (Ready to use)

27



**FULL BEND
3 BEND (BIG)**

Height : 6 ft.
Width : 3 Ft
Rod : 6+10
Weight : 6 Kg.
Outer Pipe 1 Inch.
Inner Pipe 5/8

28

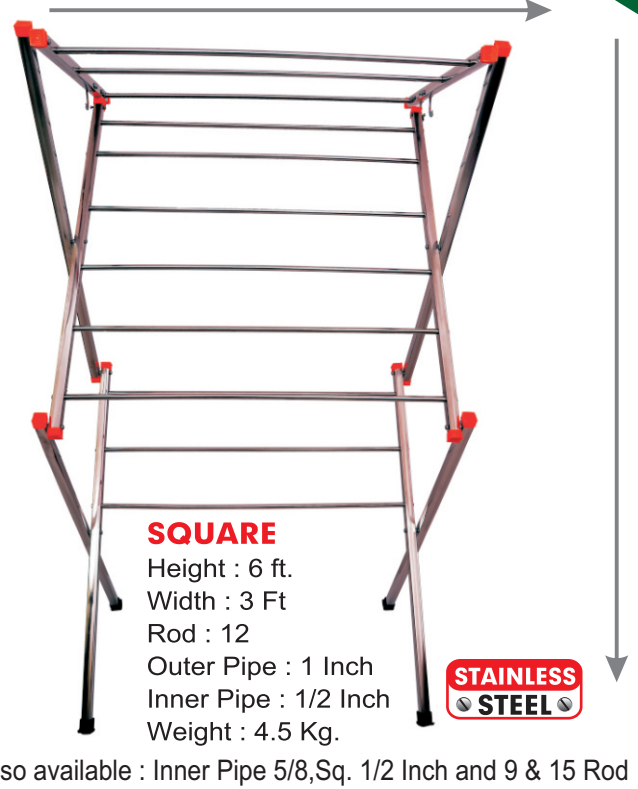

SQUARE

Height : 6 ft.
Width : 3 Ft
Rod : 12
Outer Pipe : 1 Inch
Inner Pipe : 1/2 Inch
Weight : 4.5 Kg.

Also available : Inner Pipe 5/8, Sq. 1/2 Inch and 9 & 15 Rod

29

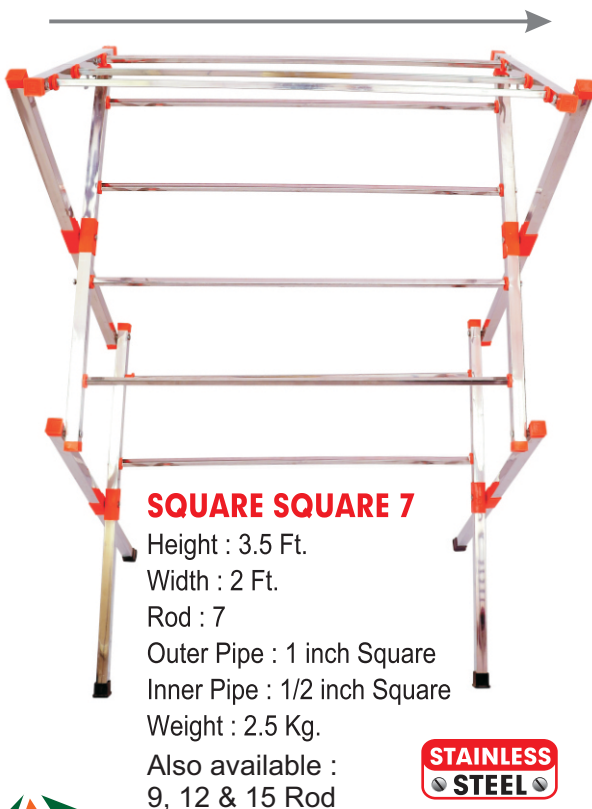

SQUARE SQUARE 7

Height : 3.5 Ft.
Width : 2 Ft.
Rod : 7
Outer Pipe : 1 inch Square
Inner Pipe : 1/2 inch Square
Weight : 2.5 Kg.
Also available :
9, 12 & 15 Rod

30

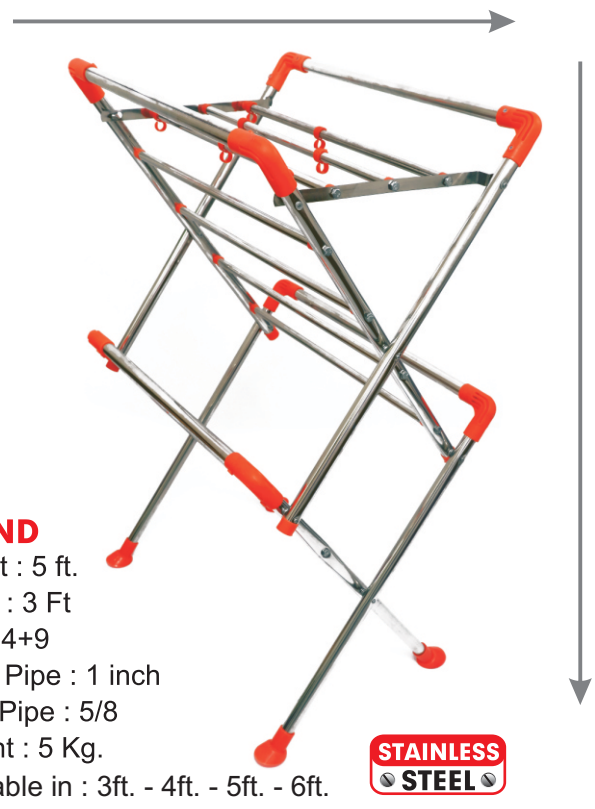

L BEND

Height : 5 ft.
Width : 3 Ft
Rod : 4+9
Outer Pipe : 1 inch
Inner Pipe : 5/8
Weight : 5 Kg.
Available in : 3ft. - 4ft. - 5ft. - 6ft.

STAINLESS STEEL
HEAVY DUTY



CLOTH DRYING STANDS

STORAGE SAVE SUITABLE FOR BOTH INDOOR & OUTDOOR

31



L BEND

Height : 6 ft.
Width : 3 Ft
Rod : 4+12
Outer Pipe : 1 inch
Inner Pipe : 5/8
Weight : 5.5 Kg.



32

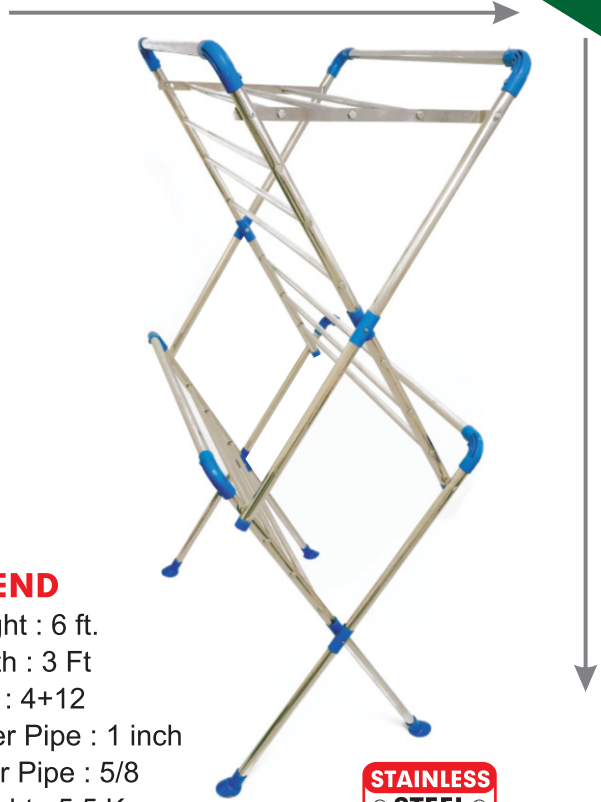

L BEND

Height : 6 ft.
Width : 3 Ft
Rod : 4+12
Outer Pipe : 1 inch
Inner Pipe : 5/8
Weight : 5.5 Kg.



33

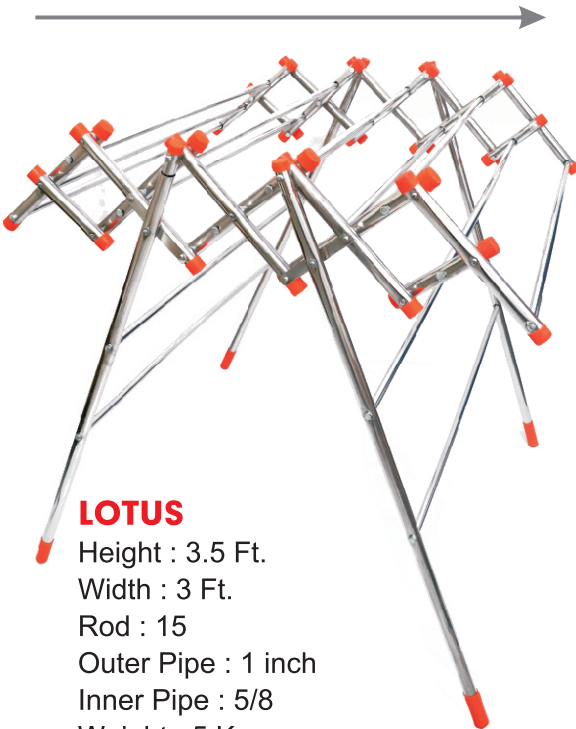

LOTUS

Height : 3.5 Ft.
Width : 3 Ft.
Rod : 15
Outer Pipe : 1 inch
Inner Pipe : 5/8
Weight : 5 Kg.



34



BUTTERFLY

Height : 40 Inch
Width : 52 Inch
Weight : 4 Kg.



Master Carton For Cloth Drying Stand

STAINLESS STEEL
HEAVY DUTY



CLOTH DRYING STANDS

STORAGE SAVE SUITABLE FOR BOTH INDOOR & OUTDOOR

35

BUTTERFLY MS



Height : 40 Inch
Width : 52 Inch
Weight : 4 Kg.

POWDER
COATED
IRON

Master Carton For Cloth Drying Stand

FULL BEND

Height : 6 ft.
Width : 3 Ft
Rod : 4+12
Outer Pipe : 1 Inch
Inner Pipe : 5/8
Weight : 6 Kg.

STAINLESS
STEEL



37

SHOE RACK



- ✓ Easy to Assemble / Foldable in Sleek Box Packing
- ✓ Hassle Free with wheel for Easy Moving.
- ✓ Multi Print Cloth available.

AVAILABLE IN :

SHELF 3

SHELF 4

SHELF 5

SHELF 6



Using lightweight pipes
multi-positional (Ready to use)

STAINLESS STEEL
HEAVY DUTY



MULTI PURPOSE RACKS

STORAGE SAVE SUITABLE FOR BOTH INDOOR & OUTDOOR

Both Article Available in : With Cover-Wheel & Without Cover-Wheel

38



SHOE RACK

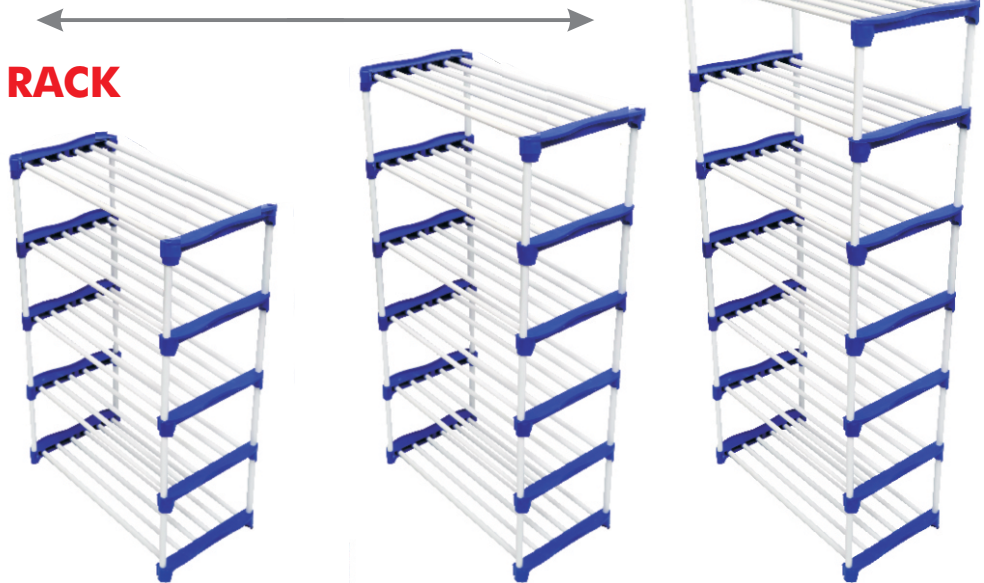
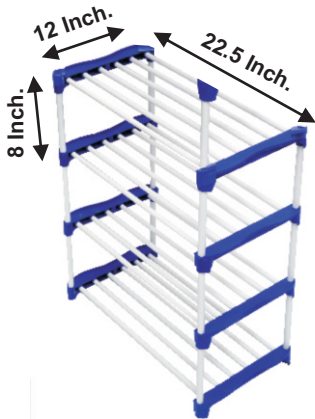

SHOE RACK HEAVY DUTY



Shoe Rack



Multipurpose Rack

39

40

- ✓ Easy to Assemble / Foldable in Sleek Box Packing
- ✓ Hassle Free with wheel for Easy Moving.
- ✓ Multi Print Cloth available.

AVAILABLE IN :

SHELF 3

SHELF 4

SHELF 5

SHELF 6



Using lightweight pipes multi-positional (Ready to use)

STAINLESS STEEL HEAVY DUTY



WALL MOUNTED SHOE RACKS

STORAGE SAVE SUITABLE FOR BOTH INDOOR & OUTDOOR

41

MULTIPURPOSE RACK



	3 Shelf	4 Shelf	5 Shelf
Length	28 Inch.	35 Inch.	45 Inch.
Width	22 Inch.	22 Inch.	22 Inch.
Depth	12 Inch.	12 Inch.	12 Inch.

Air Ventilation on Both Side Panels of Racks Which makes clean & hygienic

42

WALL MOUNTED IRON SHOE CABINET WITH DOUBLE DECKER



	4 Shelf	3 Shelf
Depth	9 Inch.	9 Inch.
Width	26 Inch.	26 Inch.
Height	65 Inch	48.5 Inch
Guage	24	24
Weight	24.0 Kgs.	19.5 Kgs.

AVAILABLE IN 3 & 4 SHELF



Single Lock For All Shelf



	2 Shelf	3 Shelf	4 Shelf	5 Shelf
Depth	5.5 Inch.	5.5 Inch.	5.5 Inch.	5.5 Inch.
Width	26 Inch.	26 Inch.	26 Inch.	26 Inch.
Height	30 Inch	42 Inch	54 Inch	67 Inch
Guage	24	24	24	24
Weight	9.0 Kgs.	12.5 Kgs.	15.0 Kgs.	18.5 Kgs.

Shoe Cabinet Packing



IRON MAKE POWDER COATED HEAVY DUTY



WINGER & BIG WINGS

STORAGE SAVE SUITABLE FOR BOTH INDOOR & OUTDOOR

43

WINGER 1

43-A



STAINLESS STEEL

Width : 39 Inch.
Height : 60 Inch
Depth : 24 Inch.
Weight : 4.9 Kgs.

WINGER 2

43-B



STAINLESS STEEL

Width : 48 Inch.
Height : 60 Inch
Depth : 24 Inch.
Weight : 8.2 Kgs.

BIG WINGS (FULL STEEL)

43-C



STAINLESS STEEL

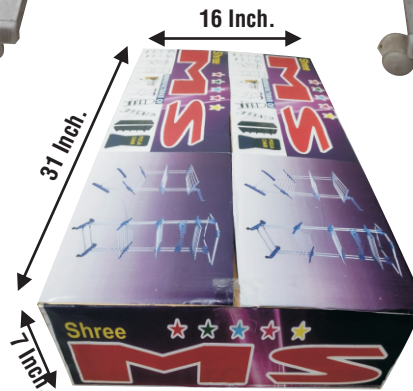

Width : 27 Inch.
Height : 81 Inch
Depth : 27 Inch.
Weight : 9.0 Kgs.

STAINLESS STEEL
HEAVY DUTY



STORAGE SAVE SUITABLE FOR BOTH INDOOR & OUTDOOR

BLACK LADDERS (IRON) HEAVY DUTY

44



Height 37.5" Width 18.5" Weight 4.1 Kgs.

Height 48" Width 18.5" Weight 5.8 Kgs.

Height 59" Width 18.5" Weight 7.2 Kgs.

Height 69" Width 18.5" Weight 8.0 Kgs.

Height 78" Width 18.5" Weight 9.5 Kgs.

- ✓ For Indoor and Outdoor
- ✓ Easy To Carry
- ✓ Save space when Folded Iron Ladder with Powder Coated



Platform

- Stronger platform ensures safety
- For better performance & durability
- Sustains heavier weights



Knee Guard

- Prevents fall ensuring safety while on top
- Scientifically designed for safety



Anti skid shoe

- Enables safe usage on smooth surface
- Sturdy shoes for firm grip



Safety Clutch Lock

- Ensures security and safety
- Keeps platform in desired position

AVAILABLE IN :

STEPS 2

STEPS 3

STEPS 4

STEPS 5

STEPS 6

STEPS 7



WEATHER RESISTANT



NO TOOL REQUIRED



Ladder Packing

STRONG PRO

45

ALUMINIUM LADDER

46

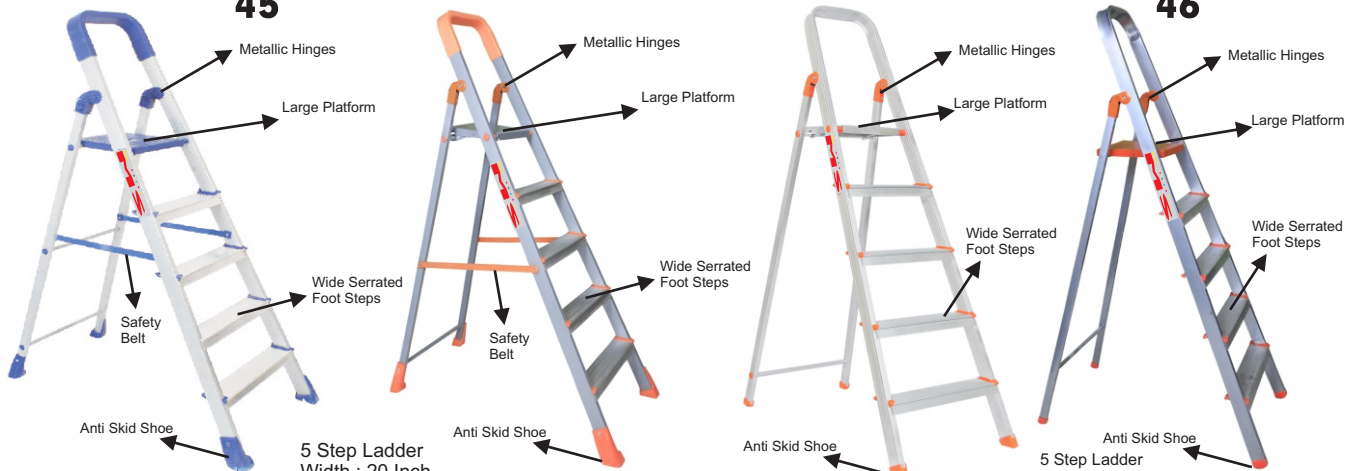

5 Step Ladder
Width : 20 Inch.
Height : 77 Inch.
Weight : 7.0 Kgs.

5 Step Ladder
Width : 13 Inch.
Height : 69 Inch.
Weight : 3.6 Kgs.

AVAILABLE IN :

STEPS 4

STEPS 5

STEPS 6

STEPS 7

STEPS 8



NO TOOL REQUIRED

STAINLESS STEEL
HEAVY DUTY



STORAGE SAVE SUITABLE FOR BOTH INDOOR & OUTDOOR

YELLOW LADDERS (IRON) HEAVY DUTY

47



Height 37.5" Width 18.5" Weight 4.1 Kgs.

Height 48" Width 18.5" Weight 5.8 Kgs.

Height 59" Width 18.5" Weight 7.2 Kgs.

Height 69" Width 18.5" Weight 8.0 Kgs.

Height 78" Width 18.5" Weight 9.5 Kgs.

- ✓ For Indoor and Outdoor
- ✓ Easy To Carry
- ✓ Save space when Folded Iron Ladder with Powder Coated



Platform

- Stronger platform ensures safety
- For better performance & durability
- Sustains heavier weights



Knee Guard

- Prevents fall ensuring safety while on top
- Scientifically designed for safety



Anti skid shoe

- Enables safe usage on smooth surface
- Sturdy shoes for firm grip



Safety Clutch Lock

- Ensures security and safety
- Keeps platform in desired position

AVAILABLE IN :

STEPS 2

STEPS 3

STEPS 4

STEPS 5

STEPS 6

STEPS 7



WEATHER RESISTANT



NO TOOL REQUIRED



Ladder Packing

CONVENTENT : Each product is ergonomically designed with Easy and convenience to your daily household tasks.

TELESCOPIC LADDERS

47A

Size Available

2.0 m

2.9 m

3.2 m

3.8 m

4.1 m

4.4 m

5.0 m

5.4 m

5.8 m

6.2 m

7.0 m

7.5 m

8.0 m



WALL HANGING (MOUNTED)

ALUMINIUM, STAINLESS STEEL & IRON POWDER COATED

48

Height : 1 Ft.

Width : 2.5 Ft.

Depth : 1.5 Ft.

Weight : 1.5 Kg.

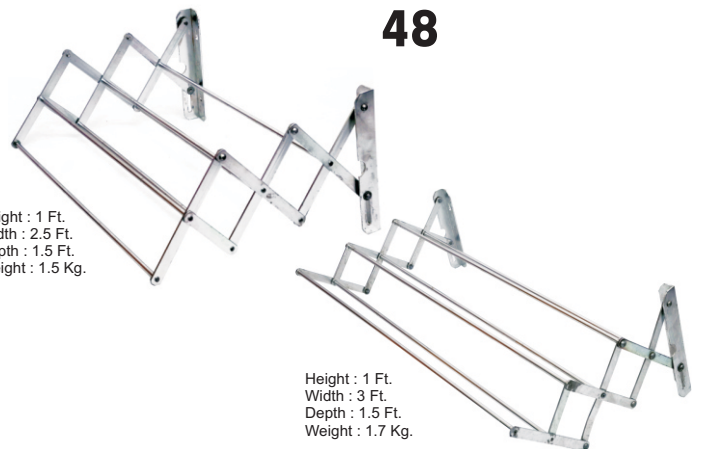

Height : 1 Ft.

Width : 3 Ft.

Depth : 1.5 Ft.

Weight : 1.7 Kg.

STAINLESS STEEL HEAVY DUTY



PRESS TABLE & STUDY TABLE

STORAGE SAVE SUITABLE FOR BOTH INDOOR & OUTDOOR

49

PRESS TABLE

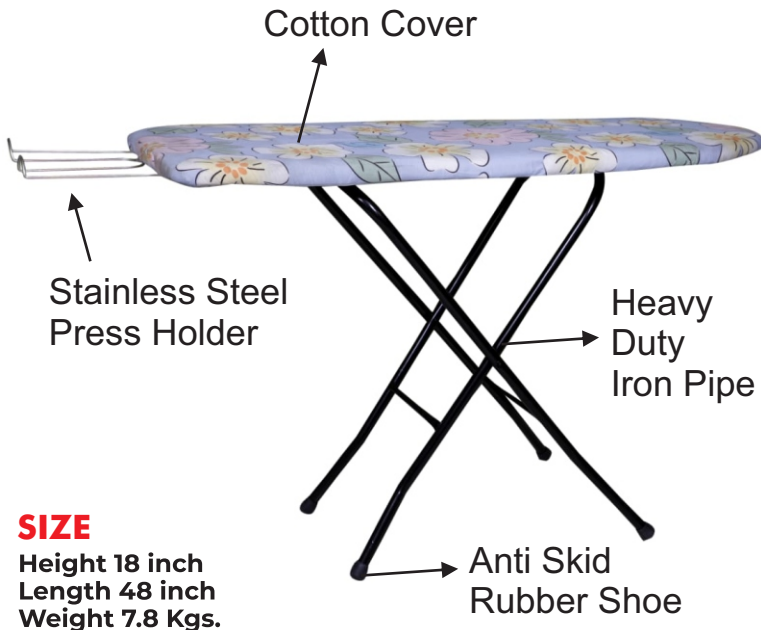

SIZE

Height 18 inch
Length 48 inch
Weight 7.8 Kgs.

- ✓ Save space when folded wooden board with Powder Coated Finish Fitted with Cover and Foam Packing Available in Different colours & Attractive Designs.



PRESS TABLE (MESH)



SIZE

Height 15 inch & 18 inch
Length 48 inch
Weight 7.2 Kgs.



QUALITY IS NOT AN ACT IN IS A HABIT



PRESS-TABLE & STUDY TABLE

STORAGE SAVE SUITABLE FOR BOTH INDOOR & OUTDOOR

STUDY TABLE & KIDS TABLE

50



Indian Study Table with Square Pipe
16 Inch. X 24 Inch.



Chinese Table
16 Inch. X 24 Inch.



Indian Study Table with Round Pipe
16 Inch. X 24 Inch.

L : 24 x W : 24 x H : 30 (In Inches)



L : 32 x W : 32 x H : 30
In Inches

L : 32 x W : 32 x H : 30
In Inches Round Table



L : 24 x W : 24 x H : 30
In Inches



L : 24 x W : 36 x H : 30
In Inches



L : 24 x W : 24 x H : 18
Inches



L : 24 x W : 36 x H : 30
In Inches
With Chrome Pipe



L : 24 x W : 48 x H : 30
In Inches
With Black Pipe



L : 18 x W : 29 x H : 30
Inches
With Alluminium Bidding

Wooden Made Available in Multi Colours and Attractive Designs

51

FOLDING CHAIR (ALUMINIUM)



FRONT
Height : 22 Inch
Width : 20 Inch

52

POOJA CHAIR / MEDITATION CHAIR



BACK
Height : 16 Inch
Width : 15 Inch
3 Inch Cotton Foam

53

BLACK LOTUS IRON

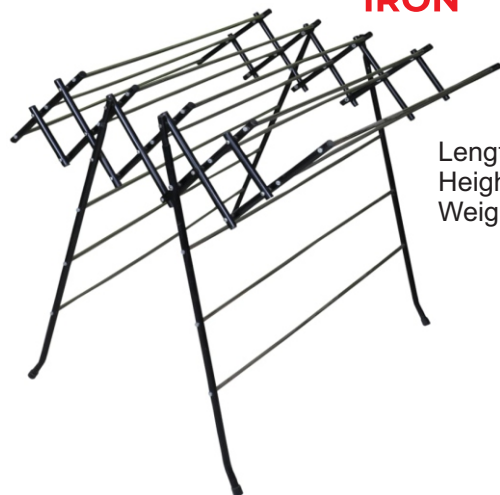

Length : 38 Inch
Height : 40 Inch
Weight : 5.3 Kgs.

QUALITY IS NOT AN ACT IN IS A HABIT



STUDYTABLE & POOJA CHAIR

STORAGE SAVE SUITABLE FOR BOTH INDOOR & OUTDOOR

IMPORTED LADDER AVAILABLE IN DIFFERENT COLOUR

54



5 STEP : 7.6 KG. APX.
6 STEP : 9.2 KG. APX.
7 STEP : 10.8 KG. APX.
Space Between Steps 13 Inch.
Six Step Ladder Height 77 Inch.
Ladder Width From Top 14 Inch.
From Bottom 16 Inch.



5 STEP : 5.5 KG. APX.
6 STEP : 6.5 KG. APX.
7 STEP : 7.5 KG. APX.

Space Between Steps 11 Inch.
Six Step Ladder Height 75 Inch.
Ladder Width From Top 13 Inch.
From Bottom 18 Inch.

STAINLESS STEEL
HEAVY DUTY



STORAGE SAVE SUITABLE FOR BOTH INDOOR & OUTDOOR

VEGETABLE TROLLEY

55



SS FOLDING CLOTH DRYING STAND



WIEGHT
2 Shelf - 3.865 Kg. (App.)
3 Shelf - 5.245 Kg. (App.)
4 Shelf - 6.825 Kg. (App.)
5 Shelf - 8.205 Kg. (App.)



PACKING DIMENSIONS

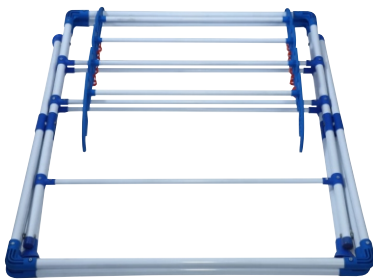

SUMO MS FOLDING STYLE



27 Inch. Shoe Rack



13.5 Inch. 36 Inch. Cloth Drying Stand

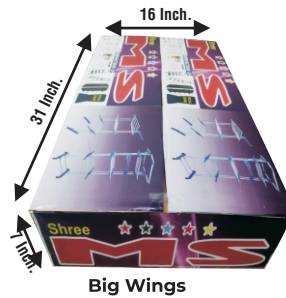

16 Inch. 31 Inch. 1 Inch. Shree Big Wings



5 Inch. 12 Inch. 27 Inch. Multipurpose Rack



Shoe Cabinet



Cloth Drying Stand 15 Pcs Wooden Petti Packing



59 Inch. 27 Inch. 27 Inch. Master Carton For Cloth Drying Stand



150kg LOAD CAPACITY Ladder



42.5 Inch. 9 Inch. 9 Inch. Sumo Cloth Drying Stand

QUALITY IS NOT AN ACT IN IS A HABIT



STORAGE SAVE SUITABLE FOR BOTH INDOOR & OUTDOOR

SHREE

MS

THE UNIQUE RANGE OF HOUSEHOLD PRODUCTS

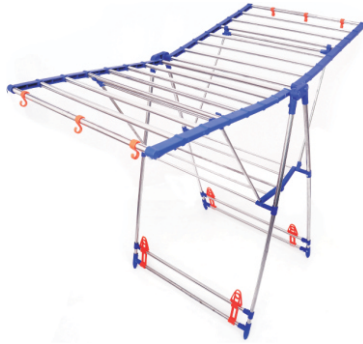

Our Mission

At Maa Santoshi Fabricators, our mission is to design and deliver products that bring comfort, convenience and efficiency to everyday life. We are committed to :

- Enhancing Quality Standards
- Space-Saving Innovations
- Customer-Centric Approach
- Eco-Friendly Solutions
- Affordable Excellence

Our Vision

Our vision is to become a leading household and office furniture manufacture in India by setting benchmarks in innovation, quality and customer satisfaction. We aim to :

- Be a Trusted Brand
- Drive Innovation
- Expand Reach
- Empower Modern Living
- Sustain Growth with Integrity

Manufactured by :
MAA SANTOSHI FABRICATORS
GST NO. : 07ALBPK4531E1ZJ

- 📍 Shiv Vihar Colony, Karala, Delhi-110081
- ☎ 7888388849 📞 +91-9810299260
- ✉ msfabricators89@gmail.com
- 🌐 www.maasantoshifabricators.net
ms.thankyoubuyers.com ; msfabricator.in



FOR PAYMENT

Follow us :



GOOGLE



TRADE INDIA



@M.S.FABRICATORS89
INSTAGRAM



YOUTUBE

QUALITY IS NOT AN ACT IN IS A HABIT